

### 1 . Features

- Wide 2 : 1 Input Range
- Low Ripple And Noise
- Input / Output Isolation 1.5K Vdc Or 3K Vdc
- 100% Burn-In
- Input - Filter
- Custom Design Available
- Net Weight : 24 g / 36.5 g Typical
- RoHS Converter Certified By SGS

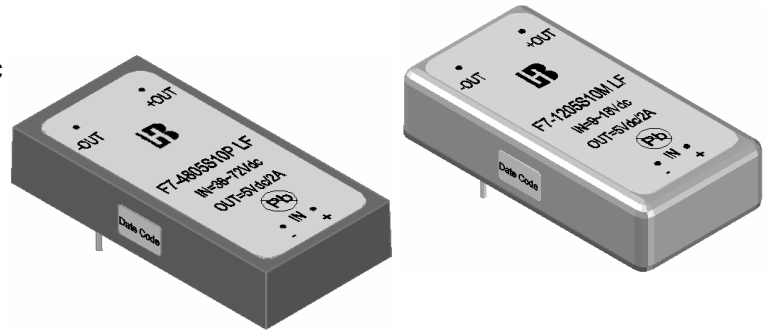

### 2 . Model Selection Guide

(Specifications typical at Ta= +25 , Nominal input voltage, Rated output current unless otherwise noted)

Model No.	Input Voltage (Vdc)	Output Voltage (Vdc)	Output Current (mA) Max	Input Current @No Load (mA) Typ.	Input Current @Max. Load (mA) Typ.	Output Ripple (mV) Max.	Load Regulation (%)Max.	Efficiency (%)Typ.
<b>1) 15 W Single Output Series</b>								
F7-123R3S15M LF	9~18	3.3	4500	10	1510	40	± 0.5	82
F7-1205S15M LF		5	3000	20	1490	50	± 0.5	84
F7-1212S15M LF		12	1250	25	1420	60	± 0.5	88
F7-1215S15M LF		15	1000	30	1400	70	± 0.5	89
F7-2405S15M LF	18~36	5	3000	20	730	50	± 0.5	85
F7-2412S15M LF		12	1250	25	700	60	± 0.5	89
F7-2415S15M LF		15	1000	30	700	70	± 0.5	89
F7-4805S15M LF	36~72	5	3000	20	365	50	± 0.5	85
F7-4815S15M LF		15	1000	30	350	70	± 0.5	89
<b>2) 15 W Dual Output Series</b>								
F7-1205D15M LF	9~18	± 5	± 1500	18	1470	50	± 2	85
F7-1212D15M LF		± 12	± 625	22	1450	100	± 2	86
F7-1215D15M LF		± 15	± 500	20	1440	120	± 2	87
F7-2405D15M LF	18~36	± 5	± 1500	18	730	50	± 2	86
F7-2412D15M LF		± 12	± 625	22	720	100	± 2	87
F7-2415D15M LF		± 15	± 500	20	710	120	± 2	88
F7-4812D15M LF	36~75	± 12	± 625	22	355	100	± 2	88
F7-4815D15M LF		± 15	± 500	20	350	120	± 2	89

Notes :

1. Standard output voltage is 3.3V, 5V, 9V, 12V, 15V, F7-xxxxSxxxx LF or F7-xxxxDxxxx LF is for customer design.



**Bothhand Enterprise**

www.Bothhand.com.tw

E-mail: sales@bothhand.com.tw

2. Load regulation is for output current change from 0% to 100% Max. load.

### 3 . Absolute Maximum Ratings

(Exceeding these values may damage the module. These are not continuous operating ratings)

Parameter	Condition	Min.	Typ.	Max.	Unit
Input Absolute Voltage Range	12V Input Model	-0.7	12	22	Vdc
	24V Input Model	-0.7	24	44	
	48V Input Model	-0.7	48	88	
Output Short Circuit Duration	Nominal Input Range	Indefinite & Auto-Restart			
Reverse Polarity Input Current Limit	---	---	---	1	A
Operation Temperature (Ambient Temperature)	Output Full Load	-25	---	+71	
Storage Temperature		-55	---	+105	

### 4 . Nominal Input/Output Electrical Specifications

(Specifications typical at Ta= +25 ,Nominal input voltage, Rated output current unless otherwise noted)

Parameter	Condition	Min.	Typ.	Max.	Unit
Input Voltage Range	12V Input Model	9	12	18	Vdc
	24V Input Model	18	24	36	
	48V Input Model	36	48	75	
Line Regulation	Output Full Load	---	---	± 0.5	%
Load Regulation	Single Output Model	---	---	± 0.5	
	Dual Output Model	---	---	± 2	
Output Voltage Accuracy	Nominal Input	---	± 1.0	± 2.0	%
Output Voltage Balance	Dual Output At Same Load	---	---	± 1.0	
Switching Frequency	Nominal Input	---	300	---	KHz
Temperature Coefficient		---	± 0.01	± 0.02	% /
Isolation Voltage	Standard Series	1500	---	---	Vdc
	High Isolation Series	3000	---	---	
Isolation Resistance	500Vdc	1000	---	---	M
Isolation Capacitance	1KHz / 250mV rms	---	1000	---	pF

### 5 . General Specification

Parameter	Specification	Condition
Isolation Voltage	1500 / 3000 Vdc	Test Duration 60 Seconds / 0.5 mA



Isolation Resistance	1000 M Min.	@ 500 Vdc
Operating Temperature (1)	-25 ~ +71	@ Ambient Temperature With Natural Convention
Operating Temperature (2)	-25 ~ +95	@ Case Surface Temperature
Storage Temperature	-55 ~ +105	---
Humidity	Up To 90 %	---
Cooling	Free Air Convection	---
Case Type	Plastic, Metal	---

### 6 . Ordering Information

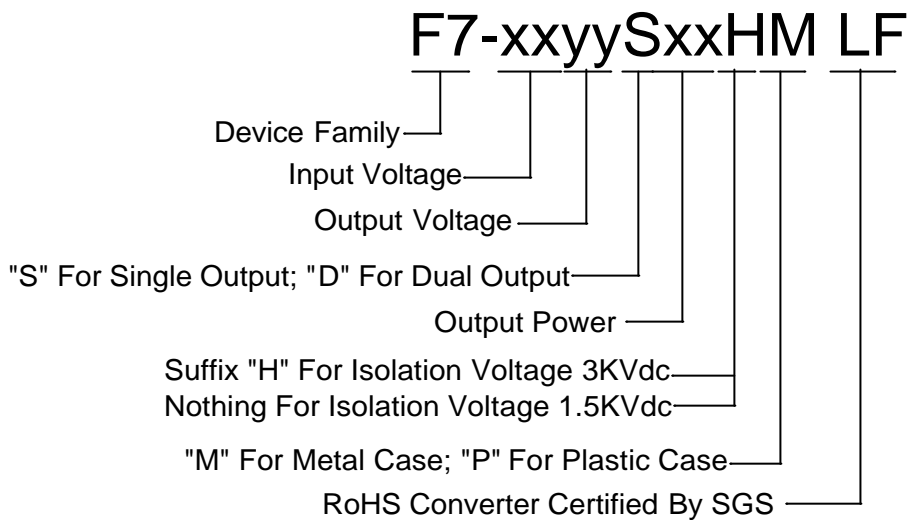

### 7 . Power Derating Curve

Temperature derating graph

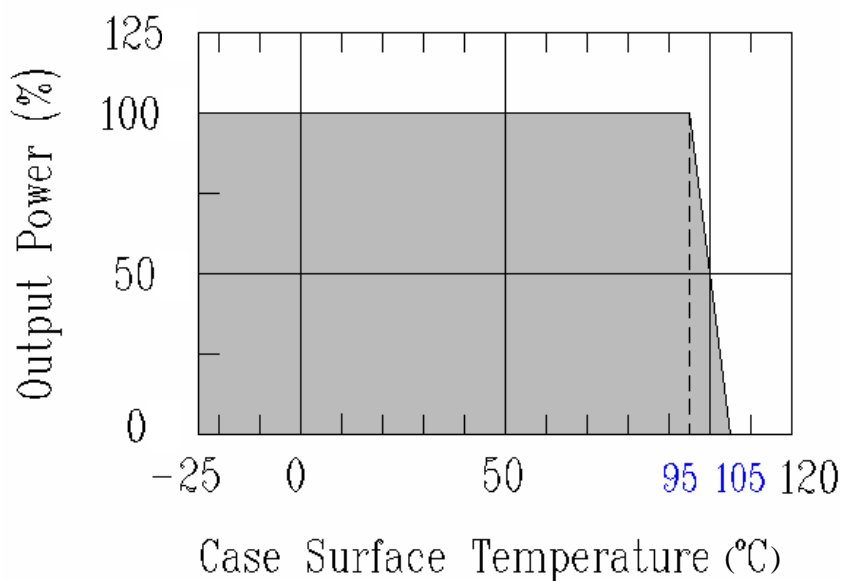

### 8 . Efficiency & Output Load Chart

Vout= 5 Vdc

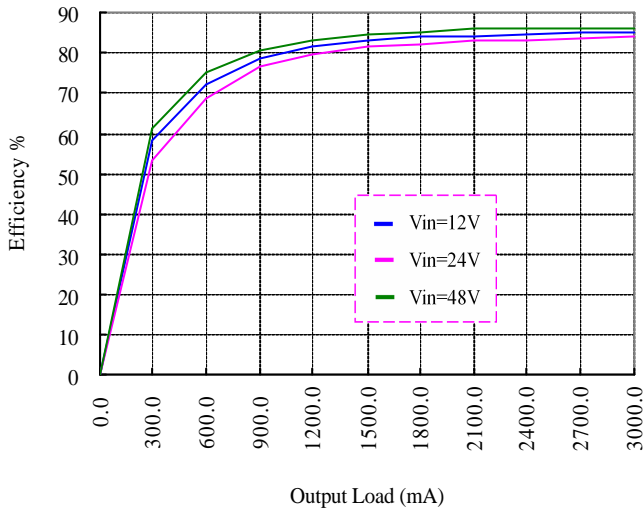

Vout= 12 Vdc

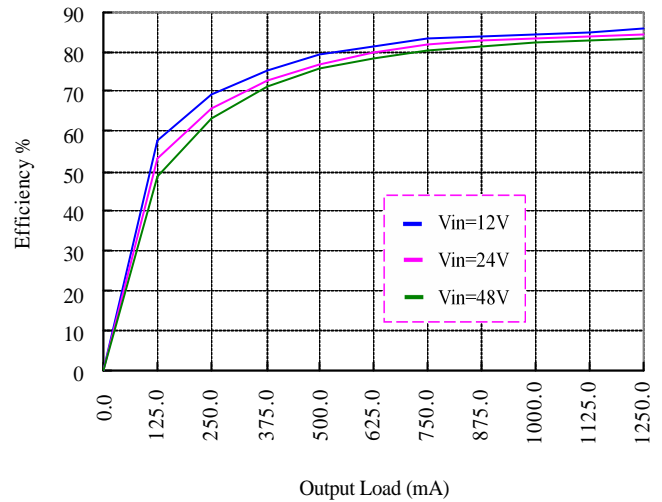

### 9 . Mechanical Dimension

#### Single Output Metal Case Model

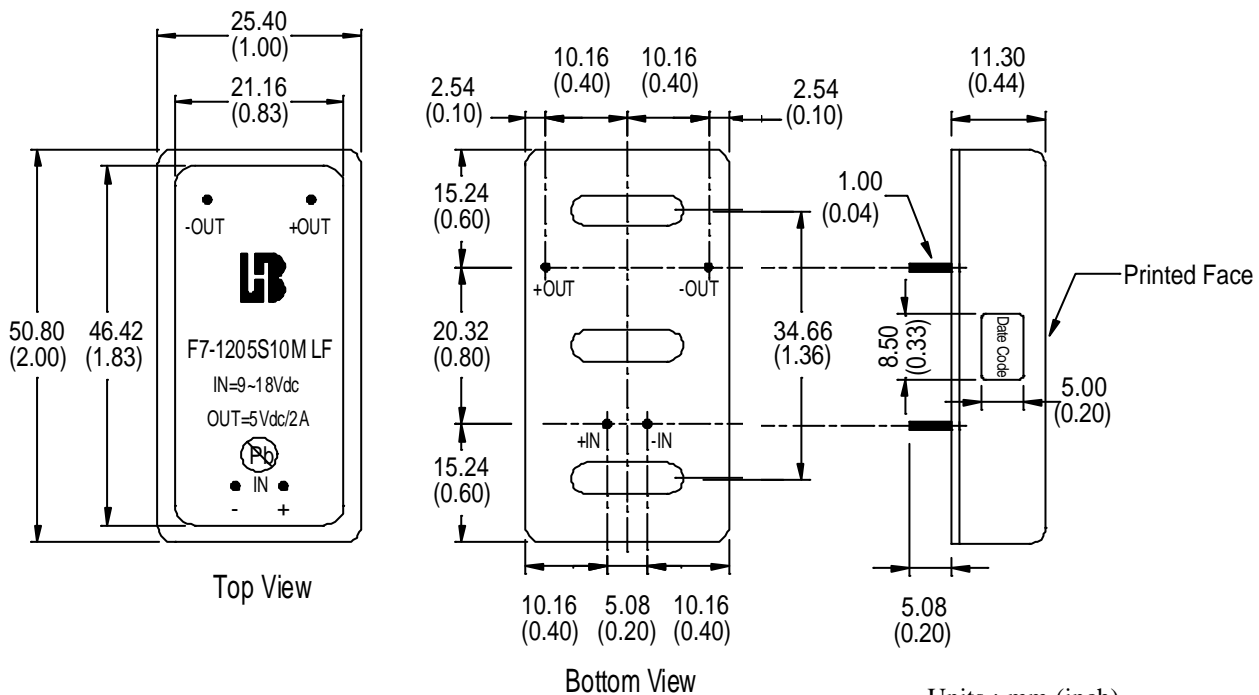

Units : mm (inch)  
Tolerance : 0.xx ± 0.25 (0.xx ± 0.01)

### Dual Output Metal Case Model

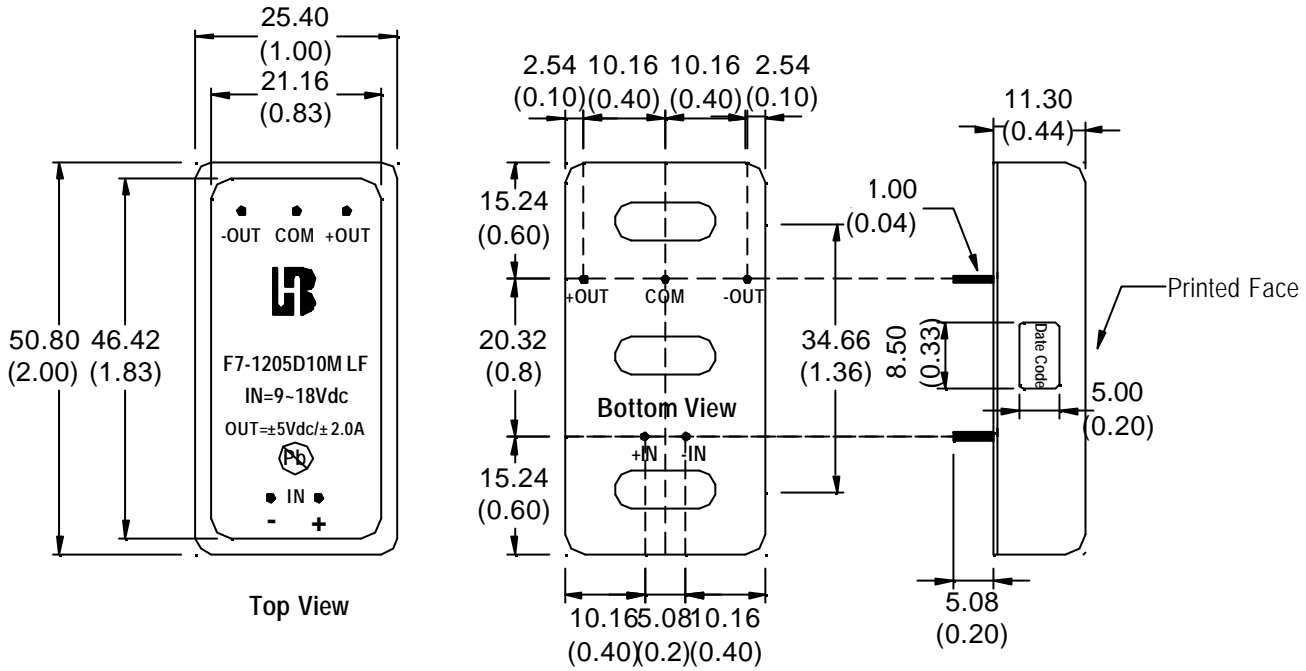

Units : mm (inch)  
Tolerance : 0.xx ± 0.25 (0.xx ± 0.01)

### Single Output Plastic Case Model

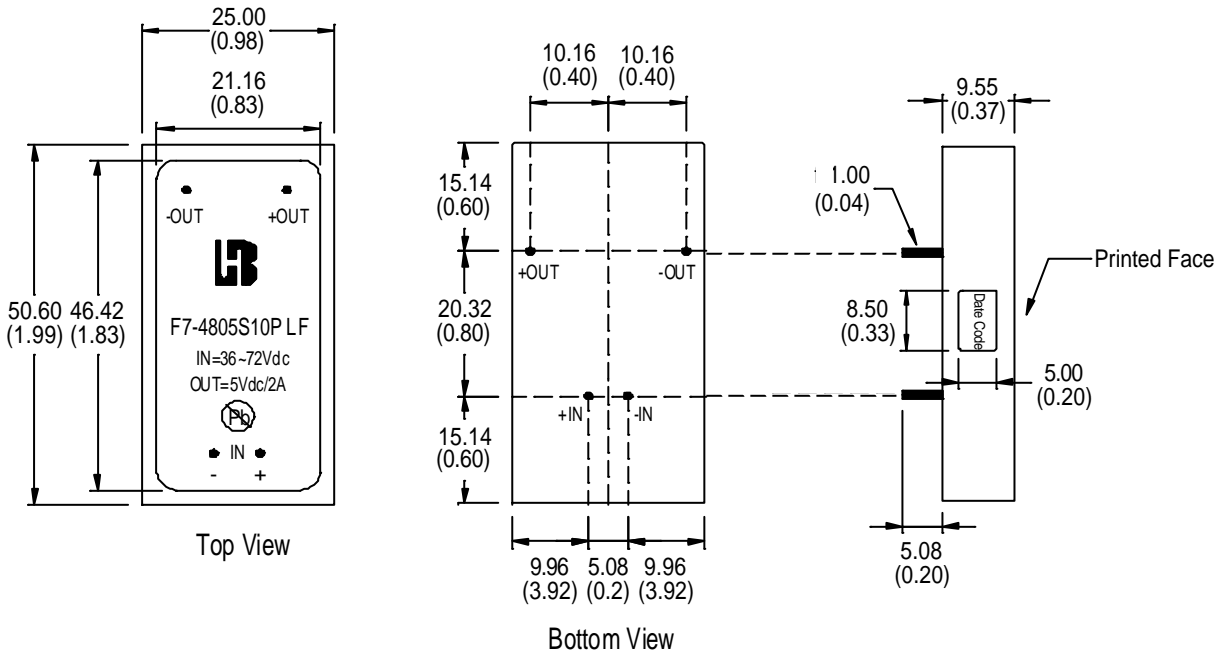

Units : mm (inch)  
Tolerance : 0.xx ± 0.25 (0.xx ± 0.01)

### Dual Output Plastic Case Model

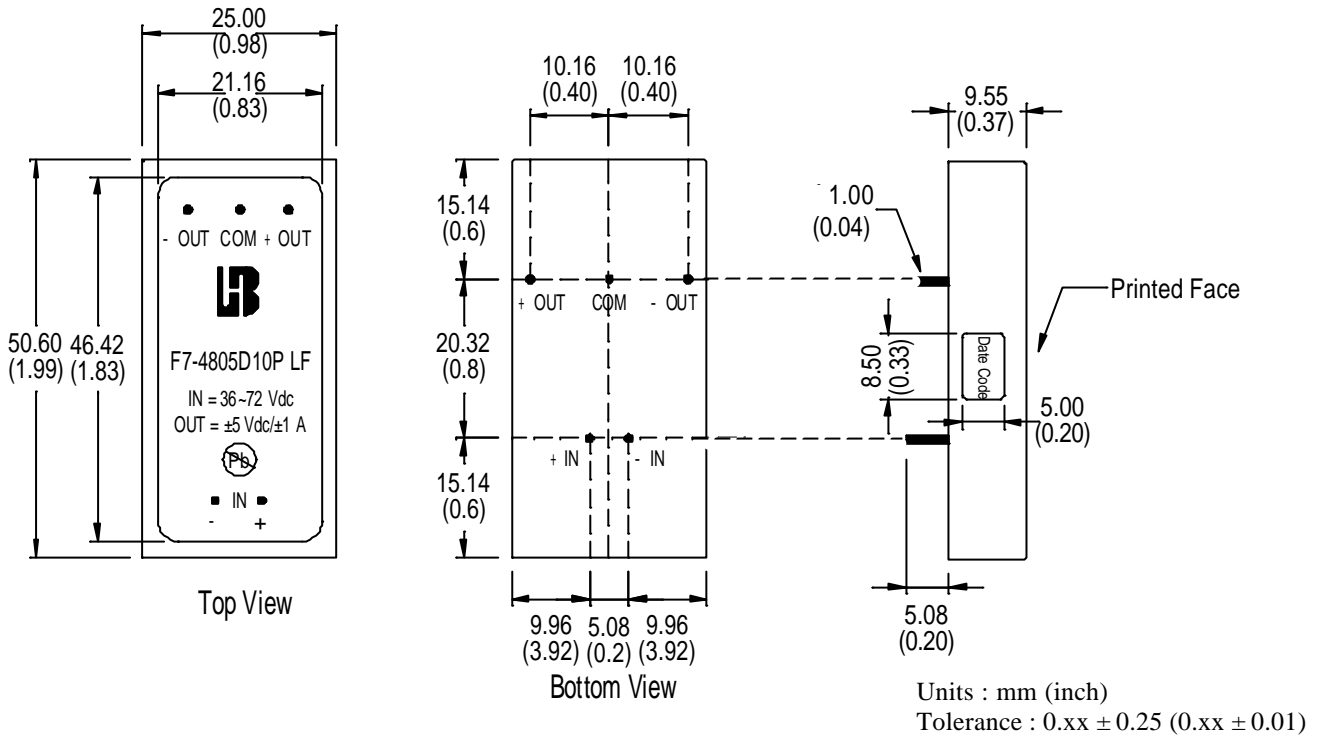

## 10 . Recommended Footprint Details

### Single Output Metal Case

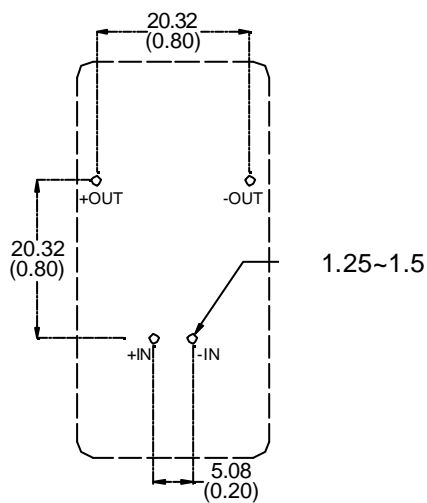

### Dual Output Metal Case

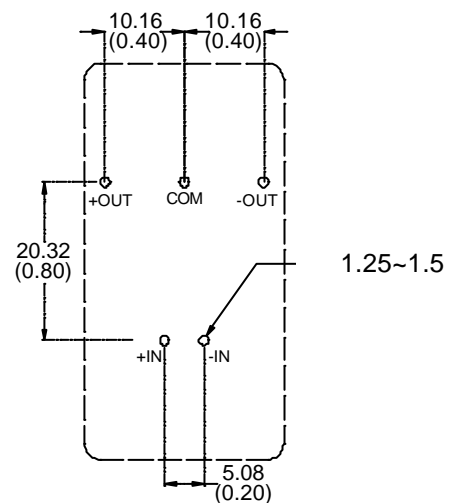

Units : mm (inch)  
Tolerance : 0.xx ± 0.25 (0.xx ± 0.01)

### Single Output Plastic Case

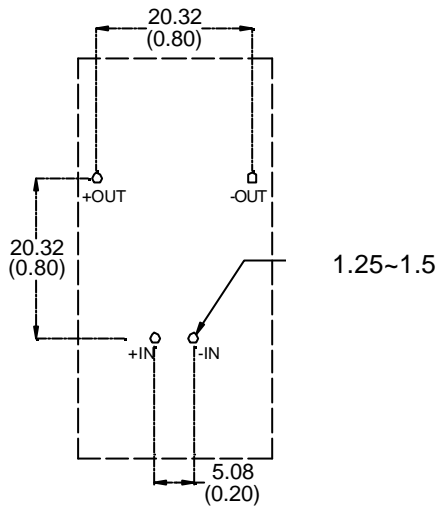

### Dual Output Plastic Case

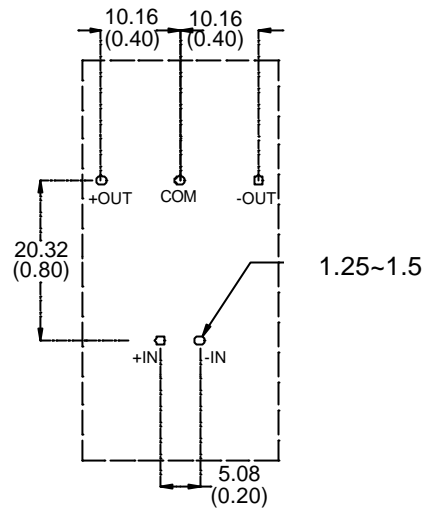

Units : mm (inch)  
Tolerance : 0.xx ± 0.25 (0.xx ± 0.01)

## 11 . Package

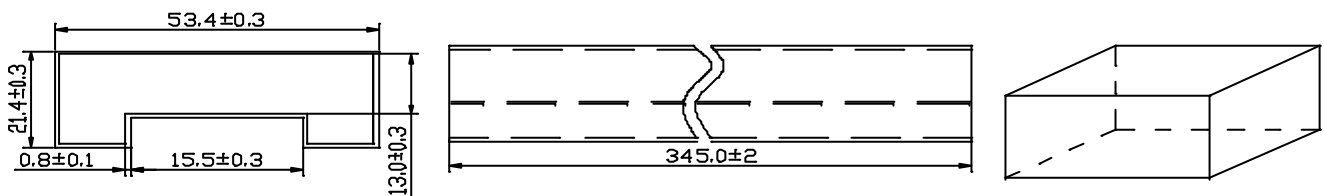

TUBE MECHANICAL DIMENSION

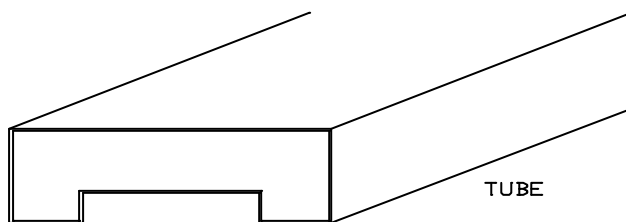

TUBE

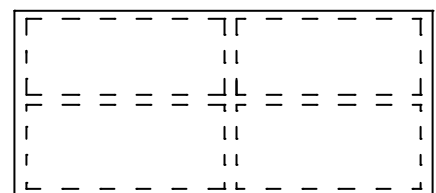

EXPORT CARTON: 405\*334\*263

1. TUBE=12PCS
2. INNER CARTON=9 TUBE=9\*12=108PCS
3. EXPORT CARTON= 4 INNER CARTON=4\*108=432PCS