

HFV6-G

AUTOMOTIVE RELAY



Typical Applications

Heaters (seat, front/rear windows), Fan motors control, Fuel pump control, Wiper motors control, Headlight control, Air-conditioning, Lighting control, Electromagnet control, Start / Stop control

Features

- 35A switching capability
- Ambient temp.: range up to 125°C
- 1 Form A & 1 Form C contact arrangement
- Plastic sealed and dust protected types available
- RoHS & ELV compliant

CHARACTERISTICS

Contact arrangement	1A, 1C	Vibration resistance ⁴⁾	5Hz to 17.3Hz 10mm DA 17.3Hz to 50Hz 58.9m/s ² 50Hz to 100Hz 29.4m/s ² 100Hz to 200Hz 19.4m/s ²
Voltage drop (initial)	NO:Typ.15mV,250mV max.(at 10A) NC:Typ.25mV,250mV max.(at 10A)	Shock resistance ⁴⁾	196m/s ² (20g)
Max. continuous current ¹⁾	NO:35A, NC: 20A	Flammability ⁵⁾	UL94-HB or better (meets FMVSS 302)
Typ. switching current	Lamp:Make inrush peak current 150A Resistive:Breake 35A	Termination	QC ⁷⁾
Max. switching voltage	16VDC	Construction	Plastic sealed, Dust protected
Min. contact load	1A 6VDC	Unit weight	Approx. 22g
Electrical endurance	1×10 ⁵ OPS	Mechanical data	cover retention (pull & push): 200N min. terminal retention (pull & push): 100N min. terminal resistance to bending (front & side): 10N min. ⁶⁾
Mechanical endurance	1 x 10 ⁷ OPS (300OPS/min)		
Initial insulation resistance	100MΩ (at 500VDC)		
Dielectric strength ²⁾	500VAC		
Operate time	Typ.: 5ms (at nomi. vol.) Max.: 10ms (at nomi. vol.)		
Release time ³⁾	Typ.: 2ms Max.: 10ms		
Ambient temperature	-40°C to 125°C		
Storage temperature	-40°C to 155°C		

- 1) For NO contacts, measured when applying 100% rated voltage on coil.
- 2) 1min, leakage current less than 1mA.
- 3) The value is measured when voltage drops suddenly from nominal voltage to 0 VDC and coil is not paralleled with suppression circuit.
- 4) When energized, opening time of NO contacts shall not exceed 100μs, when non-energized, opening time of NC contacts shall not exceed 100μs, meantime, NO contacts shall not be closed.
- 5) FMVSS: Federal Motor Vehicle Safety Standard.
- 6) Test point is at 2mm away from terminal end, and after removing testing force, the terminal transfiguration shall not exceed 0.5mm.
- 7) Do NOT knock on relays with hard objects such as rubber rod and rubber hammer during mounting, which might lead to relay damage.

CONTACT DATA ⁴⁾

Load voltage	Load type		Load current A			On/Off ratio		Electrical endurance OPS	Contact material	Load wiring diagram ³⁾	Ambient temp.
			1C		1A	On s	Off s				
			NO	NC	NO						
Standard 13.5VDC	Resistive	Make	35	20	35	2	2	1×10 ⁵	AgSnO ₂	See diagram 1	See Ambient Temp. Curve
		Break	35	20	35						
	Inductive	Make ¹⁾	80	---	80	2	2	1×10 ⁵	AgSnO ₂	See diagram 2	
		Break	30	---	30						
	Lamp	Make	150 ²⁾	---	150 ²⁾	2	2	1×10 ⁵	AgSnO ₂	See diagram 3	
		Break	30	---	30						



HONGFA RELAY

ISO9001, ISO/TS16949, ISO14001, OHSAS18001, IECQ QC 080000 CERTIFIED

2017 Rev. 1.00

- 1) Corresponds to the peak inrush current on initial actuation.
- 2) Corresponds to the peak inrush current on initial actuation (cold filament).
- 3) The load wiring diagrams are listed below:

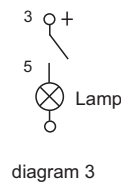
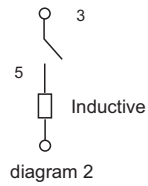
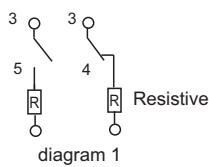

- 4) Loads mentioned in this chart is for relays with no parallel diode or Zener Diode. For those with parallel diode, Zener Diode or other components, please contact Hongfa for more technical supports.
Please also contact Hongfa if the actual application load is different from what mentioned above.

COIL DATA

at 23°C

	Nominal voltage VDC	Pick-up voltage VDC max.	Drop-out voltage VDC min.	Coil resistance x(1±10%)Ω	Parallel resistance ¹⁾ x(1±5%) Ω	Equivalent resistance x(1±10%)Ω	Power consumption W	Max. allowable overdrive voltage ²⁾ VDC	
								at 23°C	at 85°C
Standard	12	7.2	1.0	124	---	---	1.16	20	15
	12	7.2	1.0	124	680	104.9	1.37	20	15

1) The power consumption of parallel resistance is 0.5W.

2) Max. allowable overdrive voltage is stated with no load applied and minimum coil resistance.

ORDERING INFORMATION

Type		HFV6-G / 12 -Z S T N -R (XXX)	
Coil voltage	12: 12VDC		
Contact arrangement	H: 1 Form A Z: 1 Form C		
Construction ¹⁾	S: Plastic sealed ²⁾ Nil: Dust protected		
Contact material	T: AgSnO ₂		
QC Coil Terminal width	N: 2.8 mm Nil: 4.8 mm		
Parallel coil ²⁾ components	R: Parallel transient suppression resistors D: Parallel transient suppression diode, with anode connected to terminal#2 D1: Parallel transient suppression diode, with anode connected to terminal#1 Nil: Without parallel components		
Special code ³⁾	XXX: Customer special requirement		Nil: Standard

Notes: 1) Dust protected version is recommended.

2) If parallel diode, Zener Diode or other components are required, please contact Hongfa for more technical supports.

3) The customer special requirement express as special code after evaluating by Hongfa.

OUTLINE DIMENSIONS AND WIRING DIAGRAM

Unit: mm

Outline Dimensions

HFV6-G/12-Z□□-□(XXX)

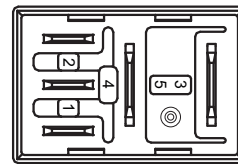
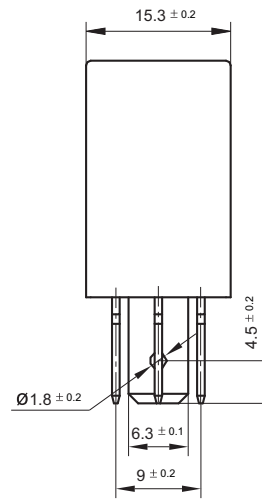
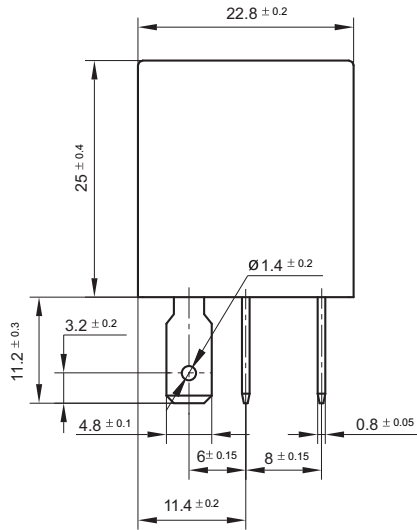

(Bottom view)

HFV6-G/12-Z□□N-□(XXX)

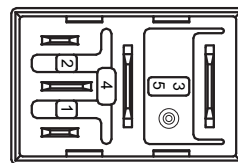
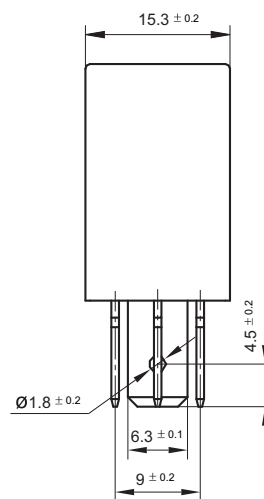
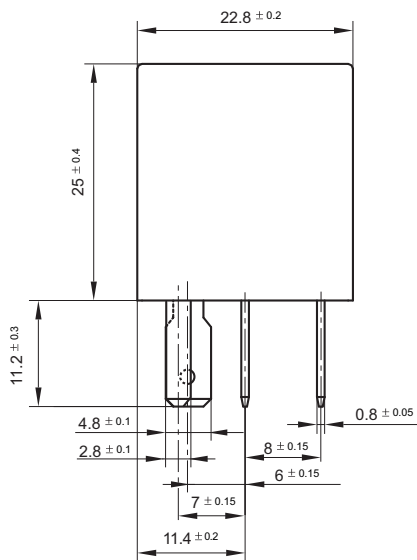

(Bottom view)

Remark: Terminal vertical deviation tolerance is 0.3mm.

OUTLINE DIMENSIONS AND WIRING DIAGRAM

Unit: mm

Wiring Diagram

HFV6-G/12-H□□□(XXX)

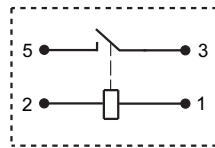

HFV6-G/12-Z□□□(XXX)

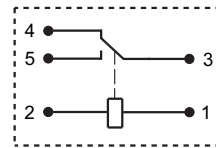

HFV6-G/12-H□□□-R(XXX)

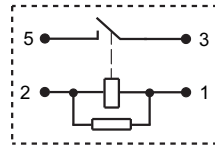

HFV6-G/12-Z□□□-R(XXX)

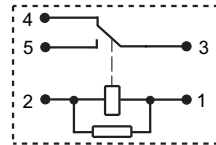

HFV6-G/12-H□□□-D(XXX)

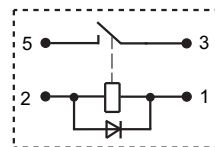

HFV6-G/12-Z□□□-D(XXX)

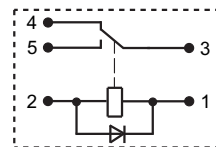

HFV6-G/12-H□□□-D1(XXX)

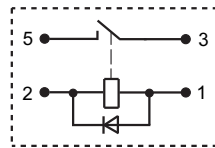

HFV6-G/12-Z□□□-D1(XXX)

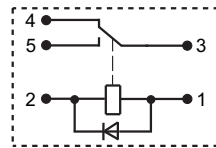

CHARACTERISTIC CURVES

Ambient temperature curve of the electrical endurance test

Ambient temp. curve (one cycle)

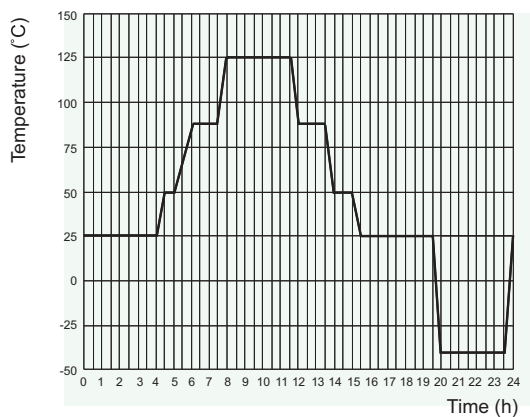

- 1) The minimum temperature is -40°C .
- 2) The maximum temperature is 125°C .

Disclaimer

The specification is for reference only. See to "Terminology and Guidelines" for more information. Specifications subject to change without notice. In case there is specific criterion (such as mission profile, technical specification, PPAP etc.) checked and agreed by and between customer and Hongfa, this specific criterion should be taken as standard regarding any requirement on Hongfa product.

We could not evaluate all the performance and all the parameters for every possible application. Thus the user should be in a right position to choose the suitable product for their own application. If there is any query, please contact Hongfa for the technical service. However, it is the user's responsibility to determine which product should be used only.

© Xiamen Hongfa Electroacoustic Co., Ltd. All rights of Hongfa are reserved.