

REVISED RECORD				
REV NO.	CONTENT	CHG BY	DATE	APPROVED BY
B2			01/18/2014	Gavin

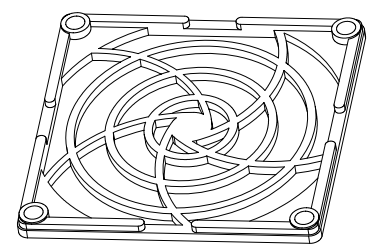

Guard

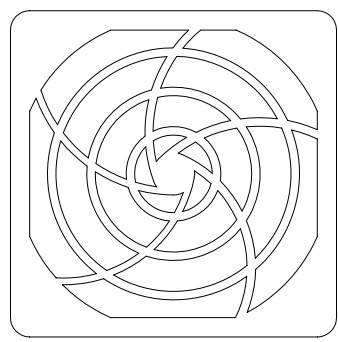
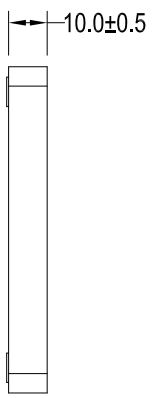
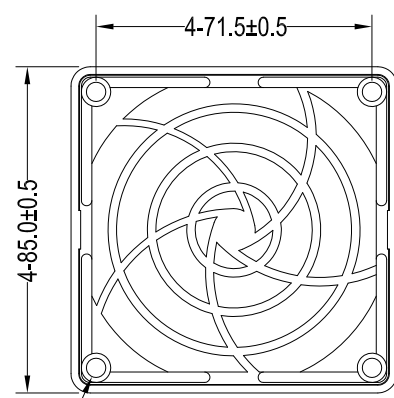
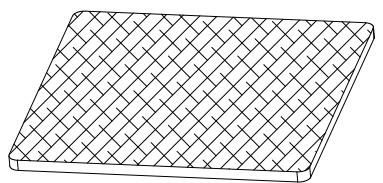

Filter

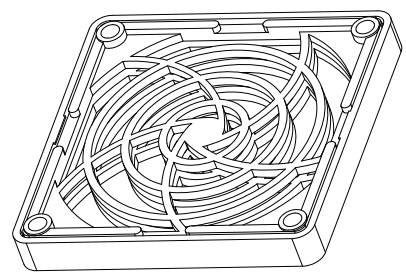

Retainer

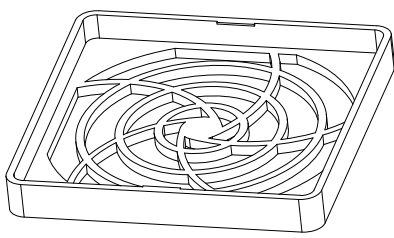

Fits for Fan Size:

- 80*80*10mm 80*80*15mm 80*80*20mm
- 80*80*25mm 80*80*32mm 80*80*38mm

Specifications:

- * Retainer & Guard Material : Flame .
-Retardant plastic ABS thermoplastic , rated UL94V0 .
- * Retainer & Guard Color : Standard black .
- * Filter material : Polyurethane (PU) Foam ; Size : 80.0*80.0*3.0mm .
- * Filter Density : 40PPI , 60PPI (pores per inch) .
- * No Burr , Flash , Bruising , Scratches .
- * Product not deformation .

UNLESS OTHERWISE SPECIFIED TOLERANCES		UNITS
0 < L ≤ 20	± 0.05	
20 < L ≤ 50	± 0.07	
50 < L ≤ 100	± 0.10	
100 < L ≤ 150	± 0.15	
150 < L ≤ 200	± 0.20	
200 < L	± 0.25	

COOLTRON INDUSTRIAL SUPPLY, INC.

DRAWN	Gavin	DATE	01/18/2014	TITLE	FPF-080A-40	
CHECKED		DATE		Drawing Number		
APPROVED		DATE		Process:	SCALE 1:1	SHT 1 OF 1
THIRD ANGLE		PROJECT				