

REVISED RECORD				
REV NO.	CONTENT	CHG BY	DATE	APPROVED BY
B2			01/18/2014	Gavin

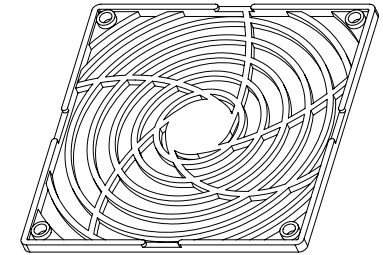

Guard

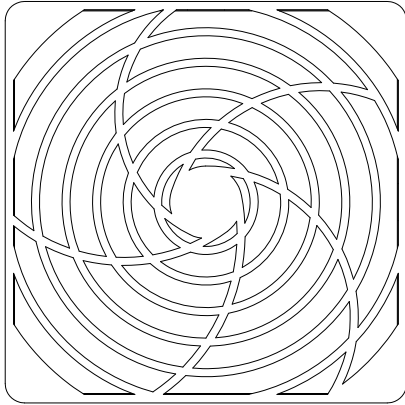
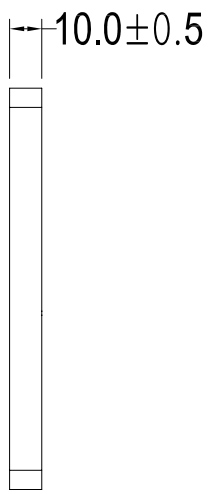
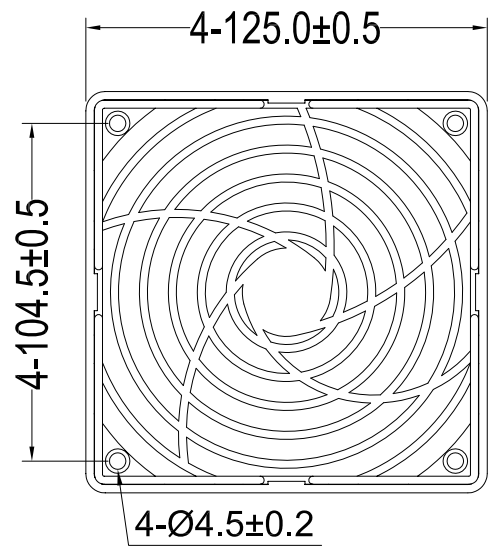
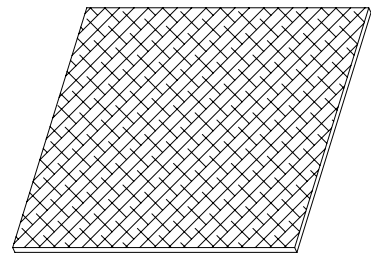

Filter

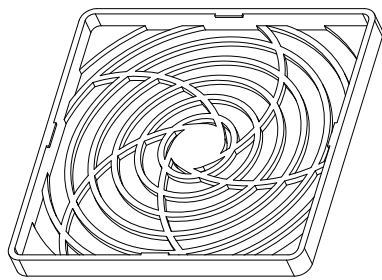
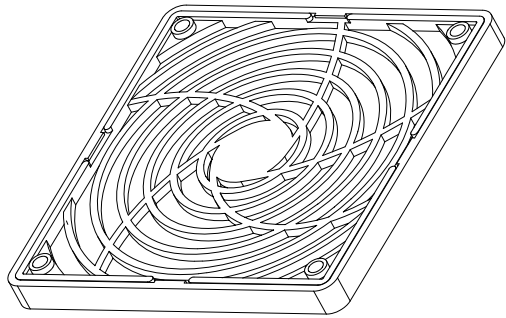

Retainer

Fits for Fan Size:
 120*120*25mm 120*120*32mm 120*120*38mm

- Specifications:
- * Retainer & Guard Material : Flame .
 -Retardant plastic ABS thermoplastic , rated UL94V0 .
 - * Retainer & Guard Color : Standard black .
 - * Filter material : Polyurethane (PU) Foam ; Size : 117.0*117.0*3.0mm .
 - * Filter Density : 40PPI , 60PPI (pores per inch) .
 - * No Burr , Flash , Bruising , Scratches .
 - * Product not deformation .

UNLESS OTHERWISE SPECIFIED TOLERANCES		UNITS
0 < L ≤ 20	± 0.05	
20 < L ≤ 50	± 0.07	
50 < L ≤ 100	± 0.10	
100 < L ≤ 150	± 0.15	
150 < L ≤ 200	± 0.20	
200 < L	± 0.25	

COOLTRON INDUSTRIAL SUPPLY, INC.
COOLTRON[®]

DRAWN	Gavin	DATE	01/18/2014	TITLE	FPF-120A-40
CHECKED		DATE		Drawing Number	
APPROVED		DATE		Process:	
THIRD ANGLE		PROJECT		SCALE	1:1
				SHT	1 OF 1