

# HFD3-VI

# SUBMINIATURE HIGH INSULATION RELAY



File No.:E133481



## Features

- Third generation Signal relay
- 2 Form A and 2 Form C configurations
- High contact switching capacity: 10mA 1000VDC/1500VDC
- SMT and DIP types available
- Single side stable and latching type available
- 6kV dielectric strength (between coil and contacts), Meet ITU-T K.21 requirement
- 2 pairs of NO contacts connected in series with contact gap  $\geq 1.5\text{mm}$ , product in accordance to IEC62776-1 available.

## CONTACT DATA

Contact arrangement	2A/2C
Contact resistance <sup>1)</sup>	$\leq 100\text{m}\Omega$ (10mA 30mVDC)
Contact material	AgNi+ Au plated
Contact rating (Res. load)	2A 30VDC
	1A 277VAC
	10mA 1500VDC 10mA 1000VDC
Max. switching voltage	1100VAC/1500VDC(Two sets of open contacts in series) 600VAC/800VDC(Single contact)
Max. switching current	4A
Max. switching power	277VA / 60W
Min. applicable load <sup>2)</sup>	10mV 10uA
Mechanical endurance	$1 \times 10^7$ OPS
Electrical endurance	$1 \times 10^5$ ops(Resistive load 85°C 2A 30VDC)
	$5 \times 10^4$ ops(Resistive load 85°C 1A 277VAC)
	$5 \times 10^4$ ops(Resistive load 105°C 10mA 1000VDC) <sup>3)</sup>
	$3 \times 10^4$ ops(Resistive load 105°C 10mA 1500VDC) <sup>3)</sup>

- Notes:** 1) The data shown above are initial values.  
 2) Min. applicable load is reference value. Please perform the confirmation test with the actual load before production since reference value may change according to switching frequencies, environmental conditions and expected contact resistance and reliability.  
 3) Two sets of open contacts or two sets of closed contacts in Series.

## CHARACTERISTICS

Insulation resistance	1000M $\Omega$ (500VDC)	
Dielectric strength	Between open contacts	1500VAC 1min
	Between contact sets	1500VAC 1min
	Between coil&contact	4000VAC 1min
Surge withstand voltage		
Between open contacts (10/160 $\mu$ s)	2.5kV	
Between coil & contacts (1.2/50 $\mu$ s)	6kV	
Between coil & contacts (10/700 $\mu$ s)	6kV <sup>2)</sup>	
Operate time (Set time)	$\leq 6\text{ms}$	
Release time (Reset time)	$\leq 6\text{ms}$	
Ambient temperature	-40°C to 85°C	
	-40°C to 105°C <sup>3)</sup>	
Humidity	5% to 85% RH	
Shock resistance	Functional	735m/s <sup>2</sup>
	Destructive	980m/s <sup>2</sup>
Vibration resistance	Functional	10Hz to 55Hz 3.3mm DA
	Destructive	10Hz to 55Hz 5.0mm DA
Termination	DIP、SMT	
Unit weight	Approx.2g	
Moisture sensitivity levels (Only for SMT type, JEDEC-STD-020)	MSL-3	
Construction	Plastic	

- Notes:** 1) The data shown above are initial values.  
 2) Product with 907 suffix, meet ITU-T K.21 requirement on surge voltage.  
 3) Product with 888 suffix is for application at 105°C.  
 4) Please see more details in the ordering information.

## COIL

Coil power	Single side stable	Approx.200mW
		Approx.280mW <sup>(2)</sup>
	1 coil latching	Approx.140mW
		Approx.200mW <sup>(2)</sup>
Temperature rise	$\leq 90\text{K}$ (2A Resistive load 85°C environment)	

- Notes:** 1) The data shown above are initial values.  
 (2) Product with 907 suffix, meet ITU-T K.21 requirement on surge voltage.

## SAFETY APPROVAL RATINGS

UL/CUL	AgNi+Au plated	2A 30VDC, at 85°C
		1A 277VAC, at 85°C
		10mA 1000VDC, at 105°C
		10mA 1500VDC, at 105°C

**Notes:** Only typical loads are listed above. Other load specifications can be available upon request.



HONGFA RELAY

ISO9001、ISO/TS16949、ISO14001、OHSAS18001、IECQ QC 080000 CERTIFIED

2019 Rev. 1.13

**COIL DATA**

at 23°C

**Single side stable**

Coil Code	Nominal Voltage VDC	Pick-up Voltage VDC max. <sup>1)</sup>	Drop-out Voltage VDC min. <sup>1)</sup>	Coil Resistance $\Omega$	Nominal Power mW approx.	Max. Voltage VDC <sup>4)</sup>
HFD3-VI/1.5	1.5	$\leq 1.13$	$\geq 0.15$	11.2 x (1 $\pm$ 10%)	200	2.2
HFD3-VI/2.4	2.4	$\leq 1.8$	$\geq 0.24$	28.8 x (1 $\pm$ 10%)	200	3.6
HFD3-VI/3	3	$\leq 2.25$	$\geq 0.3$	45x (1 $\pm$ 10%)	200	4.5
HFD3-VI/4.5	4.5	$\leq 3.38$	$\geq 0.45$	101 x (1 $\pm$ 10%)	200	6.7
HFD3-VI/5	5	$\leq 3.75$	$\geq 0.5$	125 x (1 $\pm$ 10%)	200	7.5
HFD3-VI/6	6	$\leq 4.5$	$\geq 0.6$	180 x (1 $\pm$ 10%)	200	9.0
HFD3-VI/9	9	$\leq 6.75$	$\geq 0.9$	405x (1 $\pm$ 10%)	200	13.5
HFD3-VI/12	12	$\leq 9$	$\geq 1.2$	720x (1 $\pm$ 10%)	200	18
HFD3-VI/24	24	$\leq 18$	$\geq 2.4$	2880 x (1 $\pm$ 10%)	200	36

**1 coil latching**

Coil Code	Nominal Voltage VDC	Set Voltage VDC max. <sup>1)</sup>	Reset Voltage VDC min. <sup>1)</sup>	Coil Resistance $\Omega$	Nominal Power mW approx.	Max. Voltage VDC <sup>4)</sup>
HFD3-VI/1.5-L1	1.5	$\leq 1.13$	$\leq 1.13$	16.1 x (1 $\pm$ 10%)	140	2.7
HFD3-VI/2.4-L1	2.4	$\leq 1.8$	$\leq 1.8$	41 x (1 $\pm$ 10%)	140	4.3
HFD3-VI/3-L1	3	$\leq 2.25$	$\leq 2.25$	64.3 x (1 $\pm$ 10%)	140	5.4
HFD3-VI/4.5-L1	4.5	$\leq 3.38$	$\leq 3.38$	145 x (1 $\pm$ 10%)	140	8.1
HFD3-VI/5-L1	5	$\leq 3.75$	$\leq 3.75$	178 x (1 $\pm$ 10%)	140	9
HFD3-VI/6-L1	6	$\leq 4.5$	$\leq 4.5$	257 x (1 $\pm$ 10%)	140	10.8
HFD3-VI/9-L1	9	$\leq 6.75$	$\leq 6.75$	579 x (1 $\pm$ 10%)	140	16.2
HFD3-VI/12-L1	12	$\leq 9$	$\leq 9$	1028x (1 $\pm$ 10%)	140	21.6
HFD3-VI/24-L1	24	$\leq 18$	$\leq 18$	4114 x (1 $\pm$ 10%)	140	43.2

With 907 suffix

**Single side stable**

Coil Code	Nominal Voltage VDC	Pick-up Voltage VDC max. <sup>1)</sup>	Drop-out Voltage VDC min. <sup>1)</sup>	Coil Resistance $\Omega$	Nominal Power mW approx.	Max. Voltage VDC <sup>4)</sup>
HFD3-VI/1.5	1.5	$\leq 1.13$	$\geq 0.15$	8 x (1 $\pm$ 10%)	280	1.95
HFD3-VI/2.4	2.4	$\leq 1.8$	$\geq 0.24$	20.6 x (1 $\pm$ 10%)	280	3.12
HFD3-VI/3	3	$\leq 2.25$	$\geq 0.3$	32.1x (1 $\pm$ 10%)	280	3.9
HFD3-VI/4.5	4.5	$\leq 3.38$	$\geq 0.45$	72.3 x (1 $\pm$ 10%)	280	5.85
HFD3-VI/5	5	$\leq 3.75$	$\geq 0.5$	89.3 x (1 $\pm$ 10%)	280	6.5
HFD3-VI/6	6	$\leq 4.5$	$\geq 0.6$	128.6 x (1 $\pm$ 10%)	280	7.8
HFD3-VI/9	9	$\leq 6.75$	$\geq 0.9$	289.3x (1 $\pm$ 10%)	280	11.7
HFD3-VI/12	12	$\leq 9$	$\geq 1.2$	514.3x (1 $\pm$ 10%)	280	15.6
HFD3-VI/24	24	$\leq 18$	$\geq 2.4$	1920x (1 $\pm$ 10%)	300	31.2

## COIL DATA

at 23°C

With 907 suffix

### 1 coil latching

Coil Code	Nominal Voltage VDC	Set Voltage VDC max. <sup>1)</sup>	Reset Voltage VDC min. <sup>1)</sup>	Coil Resistance Ω	Nominal Power mW approx.	Max. Voltage VDC <sup>4)</sup>
HFD3-VI/1.5-L1	1.5	≤1.13	≤1.13	11.2 x (1±10%)	200	1.95
HFD3-VI/2.4-L1	2.4	≤1.8	≤1.8	28.8 x (1±10%)	200	3.12
HFD3-VI/3-L1	3	≤2.25	≤2.25	45 x (1±10%)	200	3.9
HFD3-VI/4.5-L1	4.5	≤3.38	≤3.38	101 x (1±10%)	200	5.85
HFD3-VI/5-L1	5	≤3.75	≤3.75	125 x (1±10%)	200	6.5
HFD3-VI/6-L1	6	≤4.5	≤4.5	180 x (1±10%)	200	7.8
HFD3-VI/9-L1	9	≤6.75	≤6.75	405 x (1±10%)	200	11.7
HFD3-VI/12-L1	12	≤9	≤9	720x (1±10%)	200	15.6
HFD3-VI/24-L1	24	≤18	≤18	2880 x (1±10%)	200	31.2

**Notes:** 1)Only typical loads are listed above.Other load specifications can be available upon request.

2)When user's requirements can't be found in the above table,special order allowed.

3)In case 5V of transistor drive circuit, it is recommended to use 4.5V type relay, and 3V to use 2.4V type relay.

4)Maximum voltage refers to the maximum voltage which relay coil could endure in a short period of time.

## ORDERING INFORMATION

Type	HFD3-VI / 24 -2H -L1 3 S R (XXX)
Coil voltage	1.5, 2.4, 3, 4.5, 5, 6, 9, 12, 24VDC
Sort	2H: 2 Form A 2Z: 2 Form C
Sort	L1: 1 coil latching Nil: Single side stable
Contact material	3: AgNi+Gold plated
Terminal type	S: Standard SMT S1: Short terminal SMT Nil: DIP
Packing style	R: Tape and reel packing (Only for SMT type) <sup>1)</sup> Nil: Tube packing(Only for DIP type) <sup>2)</sup>
Special code <sup>3)</sup>	XXX: Customer special requirement Nil: Standard For insitance: Product with 907 suffix, meet ITU-T K.21 requirement on surge voltage. Product with 888 suffix is for application at 105°C. Product with 897 suffix is with pin distance at 4.58mm.

**Notes:** 1) R type (tape and reel) packing is moisture-proof which meets requirement of MSL-3. Please choose R type packing for SMT products. For R type, the letter "R" will only be printed on packing tag but not on relay cover. Tube packing is normally not available for SMT products unless specially requested by customer. But please note that tube packing is not moisture-proof so please bake the products before use according to description of Notice 11 herewith. In addition, tube packaging will be adopted when the ordering quantity of R type is equal to or less than 100 pieces unless otherwise specified.

2) The standard tube length is 624mm.

3) The customer special requirement express as special code after evaluating by Hongfa.The suffix 907, 888 & 897 are for special versions. The ordering PN should be HFD3-VI/12-2Z-3(907) for instance.

# OUTLINE DIMENSIONS, WIRING DIAGRAM AND PC BOARD LAYOUT

Unit: mm

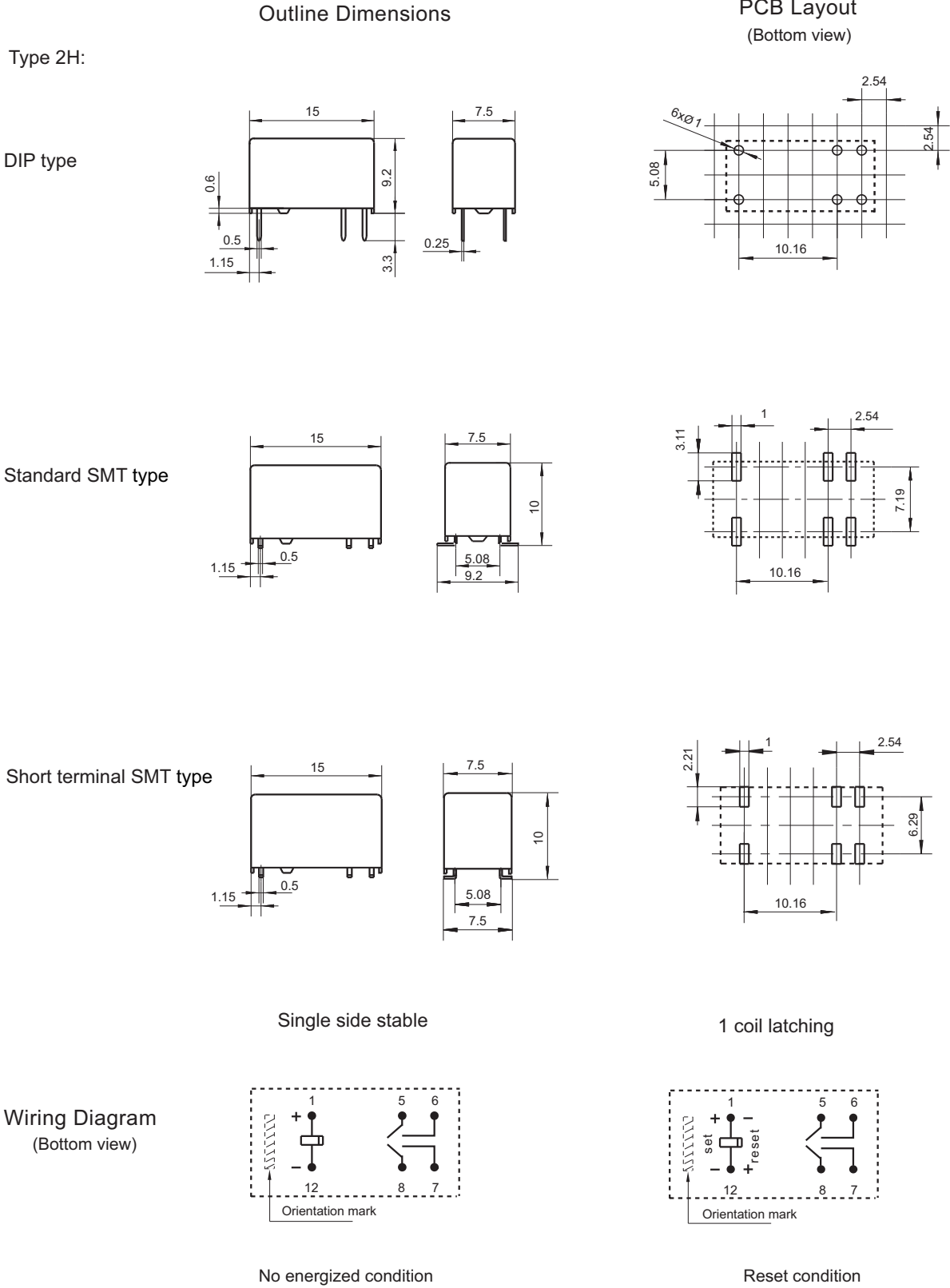

# OUTLINE DIMENSIONS, WIRING DIAGRAM AND PC BOARD LAYOUT

Unit: mm

Type 2Z:

## Outline Dimensions

## PCB Layout (Bottom view)

DIP type

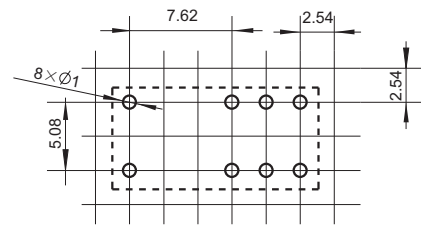
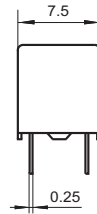
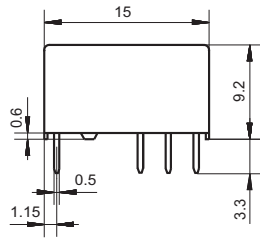

Standard SMT type

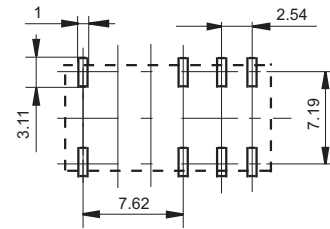
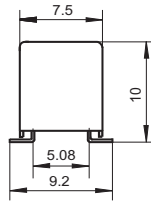
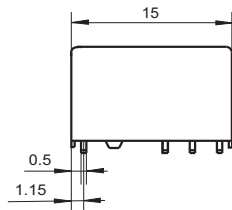

Short terminal SMT type

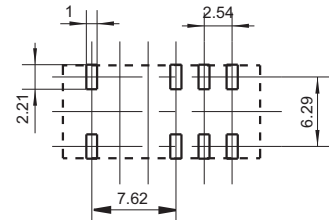
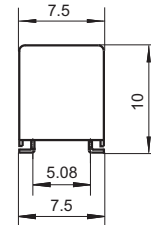
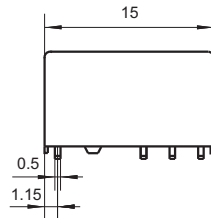

## Single side stable

## 1 coil latching

Wiring Diagram  
(Bottom view)

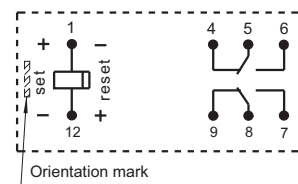
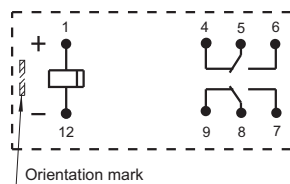

No energized condition

Reset condition

# OUTLINE DIMENSIONS, WIRING DIAGRAM AND PC BOARD LAYOUT

Unit: mm

## Outline Dimensions

## PCB Layout (Bottom view)

With 897 suffix

Type 2H:

DIP type

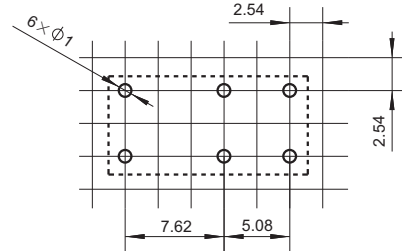
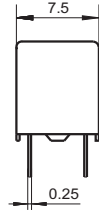
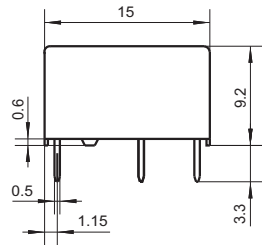

Standard SMT type

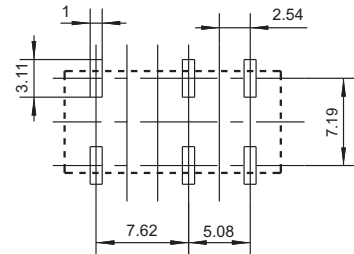
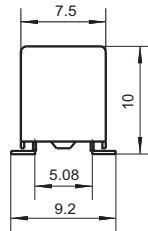
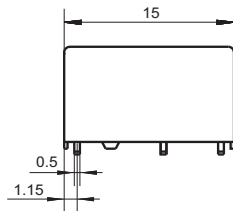

Short terminal SMT type

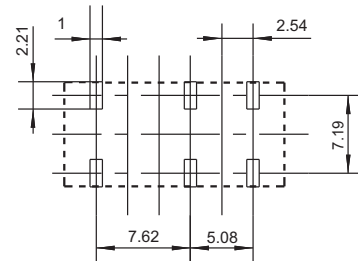
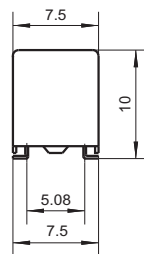
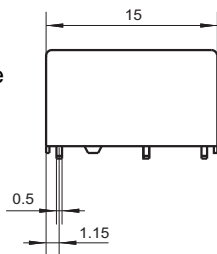

Wiring Diagram  
(Bottom view)

Single side stable

1 coil latching

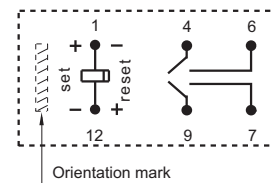
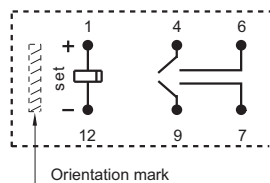

No energized condition

Reset condition

Remark:1) The size of the pin of the external map of the product is the size before the tin(after the tin is touched), and the size of the installation hole is the design size of the recommended PCB plate hole. The design size of the specific PCB plate hole can be mapped and adjusted according to the product's physical object.;

2) In case of no tolerance shown in outline dimension: outline dimension  $\leq 1\text{mm}$ , tolerance should be  $\pm 0.2\text{mm}$ ; outline dimension  $> 1\text{mm}$  and  $\leq 5\text{mm}$ , tolerance should be  $\pm 0.3\text{mm}$ ; outline dimension  $> 5\text{mm}$ , tolerance should be  $\pm 0.4\text{mm}$ .

3) The tolerance without indicating for PCB layout is always  $\pm 0.1\text{mm}$ .

**Direction of Relay Insertion**

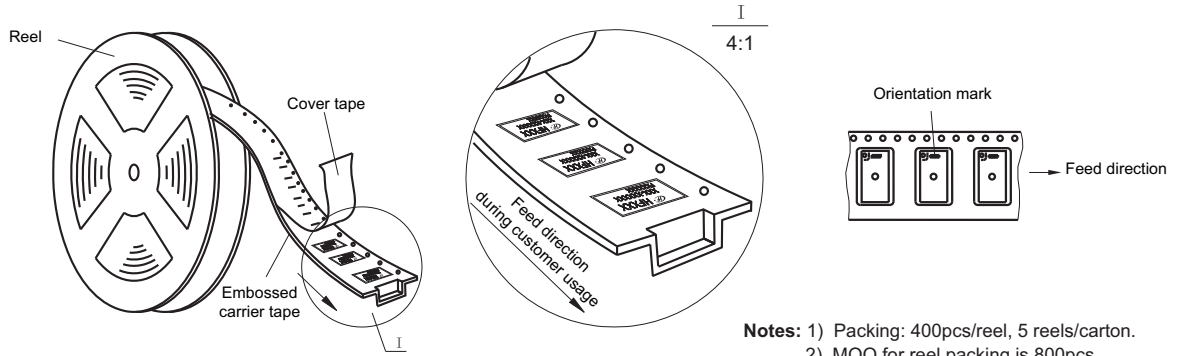

- Notes:** 1) Packing: 400pcs/reel, 5 reels/carton.  
 2) MOQ for reel packing is 800pcs

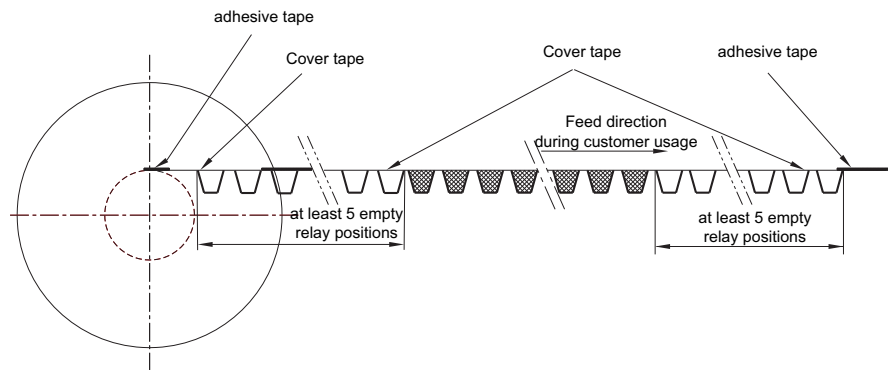

**Reel Dimensions**

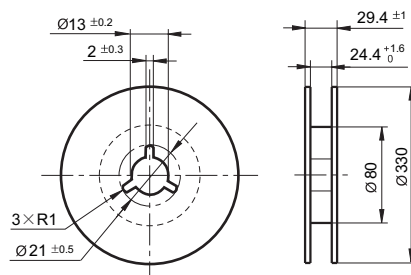

Tape Dimensions (S type: Standard SMT)

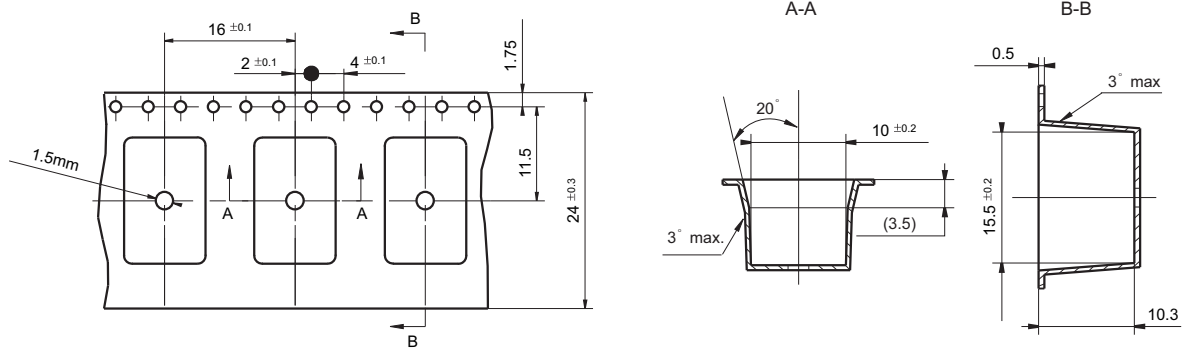

Tape Dimensions (S1 type: Short terminal SMT)

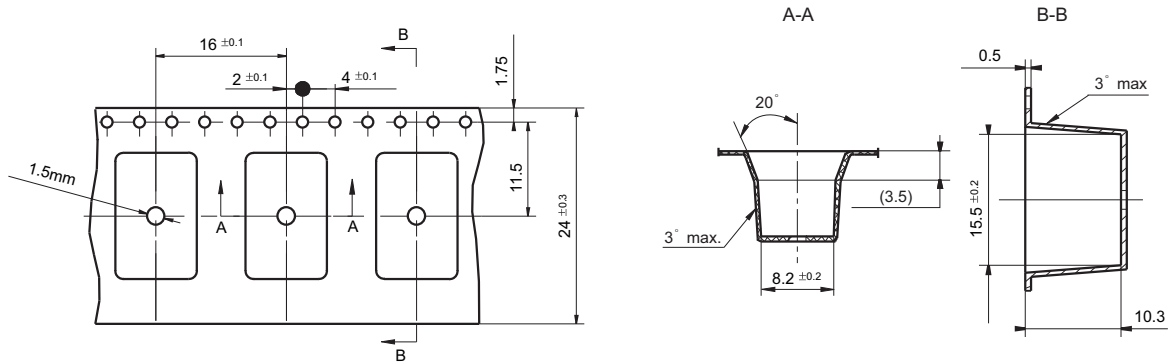

CHARACTERISTIC CURVES

MAXIMUM SWITCHING POWER

Two sets of open/closed contacts in series

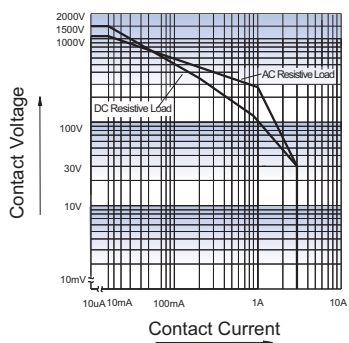

Singl contact

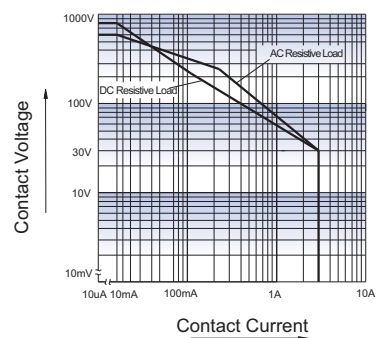



## CHARACTERISTIC CURVES

ENDURANCE CURVE

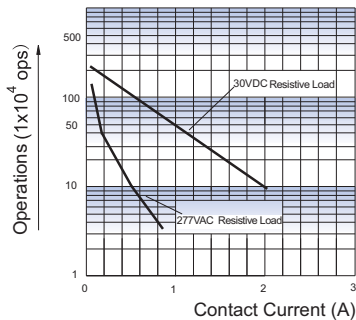

**Test conditions:**

1 form A or 1 form B

Resistive load, at 85°C, 1s on 9s off.

Temperature/Time profile of Reflow Soldering see below:

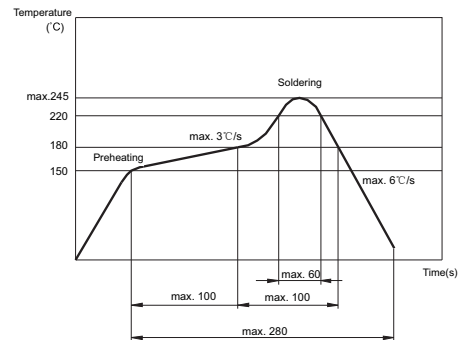

### Notice

- 1) This relay is highly sensitive polarized relay, if correct polarity is not applied to the coil terminals, the relay does not operate properly.
- 2) To avoid using relays under strong magnetic field which will change the parameters of relays such as pick-up voltage and drop-out voltage.
- 3) Relay is on the "reset" status when being released from stock, with the consideration of shock risen from transit and relay mounting, it should be changed to the "set" status when application(connecting to the power supply). Please reset the relay to "set" or "reset" status on request.
- 4) Energizing coil with rated voltage is basic for normal operation of a relay, please make sure the energized voltage to relay coil have reached the rated voltage. Regarding latching relay, in order to maintain the "set" or "reset" status, impulse width of the rated voltage applied to coil should be more than 5 times of "set" or "reset" time.
- 5) For a monosteady state relay, after the relay is reliably operated, if it needs to be kept under pressure, make sure that the effective value of the voltage is not less than 60 % of the rated voltage;
- 6) The relay may be damaged because of falling or when shocking conditions exceed the requirement.
- 7) For SMT products, validation with real application should be done before your series production, if the reflow-soldering temperature curve is out of our recommendation. Generally, two-time reflow-soldering is not recommended for the relay. However, if two-time reflow-soldering is required, a 60-min. interval should be guaranteed and a validation should be done before production.
- 8) Please use wave peak welding or manual welding for direct relay welding. If you need to return welding, please confirm the feasibility with us.
- 9) Contact is recommended for suitable condition and specifications if water cleaning or surface process is involved in assembling relays on PCB.
- 10) Regarding the plastic sealed relay, we should leave it cooling naturally until below 40°C after welding, then clean it and deal with coating, remarkably the temperature of solvents should also be controlled below 40°C. Please avoid cleaning the relay by ultrasonic, avoid using the solvents like gasoline, Freon, and so on, which would affect the configuration of relay or influence the environment.
- 11) About preferable condition of operation, storage and transportation, please refer to "Explanation to terminology and guidelines of relay".
- 12) Relays packaged in moisture barrier bags meet MSL-3 requirements. The relays should be stored at ambient conditions of  $\leq 30^\circ\text{C}$  and  $\leq 60\%$  RH after they are removed from their packaging, and should be used within 168 hours. If the relays cannot be used within 168 hours, please repack them or store them in a drying oven at  $25^\circ\text{C} \pm 5^\circ\text{C}$ ,  $\leq 10\%$  RH. Otherwise, relays may be subjected to a soldering test to check their performance, or they may be used after keeping them in an oven for 72 hours at with  $50^\circ\text{C} \pm 5^\circ\text{C}$ ,  $\leq 30\%$  RH.

### Disclaimer

The specification is for reference only. See to "Terminology and Guidelines" for more information. Specifications subject to change without notice. We could not evaluate all the performance and all the parameters for every possible application. Thus the user should be in a right position to choose the suitable product for their own application. If there is any query, please contact Hongfa for the technical service. However, it is the user's responsibility to determine which product should be used only.

© Xiamen Hongfa Electroacoustic Co., Ltd. All rights of Hongfa are reserved.